



General:	Assembled by A&I Manufacturing, Inc. Environmentally safe.
Operation:	Lift/Tilt motor, battery powered with 8 Double A batteries, Alkaline or Lithium. Optional 12V DC Plug-in Transformer.
Battery Box:	Molded plastic, used to hold 8 Double A batteries, connected to lift/tilt motor.
Battery Box Cover:	Molded plastic, only used when Battery Box is mounted outside of head rail.
Motor:	12V DC motor powered by either 8 Double AA Batteries or 12V DC transformer.
Head Rail:	1.75" x 1.50" x 1/16" extruded aluminum, integrated style. Baked-on paint, color coordinated to slats.
Bottom Rail:	Sculpted, extruded aluminum. Color coordinated to slats.
Head Rail Slat:	Aluminum Heat Treated and Tempered, 1" wide x .006 thick. Color to match head rail.
Slats:	Aluminum Heat Treated and Tempered, 1" wide x .006 thick.
Tilter:	Shall be of worm gear construction, enclosed in housing of engineering polymer; gear and shaft shall be of engineering polymer with slip clutch mechanism. May be positioned at right or left with or without cord lock.
Tilt Rod:	Shall be solid steel with corrosion resistant finish.
Braided Ladders:	Shall be 100% polyester yarn color coordinated with the slats. Spacing shall not be more than 21.5 mm. (approximately 14 slats per foot of drop).
Installation Brackets:	Standard hidden brackets, 1.5" x 1.75" x .042" Zinc Plated Steel. Blinds over 48" wide shall have intermediate supports.
Tassel:	Shall comply with all safety requirements.
Sizes:	Outside mounted window coverings will be made to exact ordered measurements. Inside mounted horizontal blinds will have 1/2" deducted at the factory from width. See Product Limits.

Product Limits

Controls (Motorized)	Min. Width	Max. Width	Min. Drop	Max. Drop
Lift/Tilt Left or Right	20"	102"	6"	114" *

Maximum Sq. Footage *114 Sq. Ft. Under Warranty

* Exceptions Available Upon Request

 WARNING	 ADVERTENCIA
 Cords on window covering products present a potential strangulation hazard.	 Las cuerdas y cadenas y persianas presentan un peligro de estrangulación.
 For child safety, consider cordless alternatives or products with inaccessible cords.	 Para la seguridad de los niños, considere alternativas sin cuerdas o productos con cuerdas y cadenas inaccesibles.
SAFLAB-3 04/2013	ANSI/WCMA 5.1.4
	SAFLAB-3 04/2013
	ANSI/WCMA 5.1.4



Motorized Aluminum Mini Exploded View

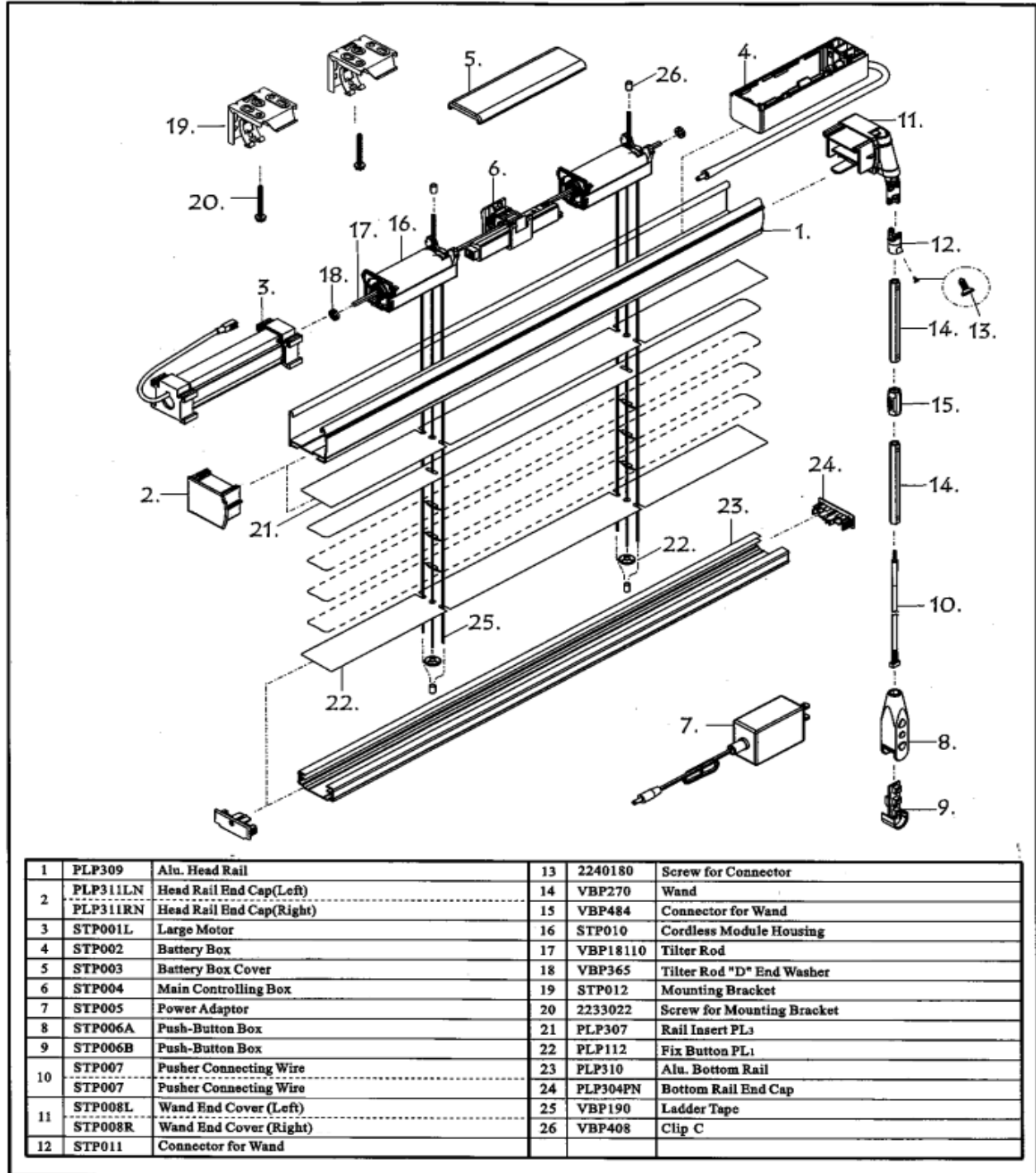



Commercial Contract Color Options (Check One)

- M1001 Shimmering White
- M1004 Igloo
- M1007 Polar Bear
- M1013 China Stone
- M1022 Coconut
- M1025 Antique Lace