



<b>General:</b>	Assembled by A&I Manufacturing, Inc. <b>Environmentally safe.</b>
<b>Operation:</b>	Lift/Tilt motor, battery powered with 8 Double A batteries, Alkaline or Lithium. Optional 12V DC Plug-in Transformer.
<b>Battery Box:</b>	Molded plastic, used to hold 8 Double A batteries, connected to lift/tilt motor.
<b>Battery Box Cover:</b>	Molded plastic, only used when Battery Box is mounted outside of head rail.
<b>Motor:</b>	12V DC motor powered by either 8 Double AA Batteries or 12V DC transformer.
<b>Head Rail:</b>	1.75" x 1.50" x 1/16" extruded aluminum, integrated style. Baked-on paint, color coordinated to slats.
<b>Bottom Rail:</b>	Sculpted, extruded aluminum. Color coordinated to slats.
<b>Head Rail Slat:</b>	Aluminum Heat Treated and Tempered, 1" wide x .008 thick. Color to match head rail.
<b>Slats:</b>	Aluminum Heat Treated and Tempered, 1" wide x .008 thick.
<b>Tilter:</b>	Shall be of worm gear construction, enclosed in housing of engineering polymer; gear and shaft shall be of engineering polymer with slip clutch mechanism. May be positioned at right or left with or without cord lock.
<b>Tilt Rod:</b>	Shall be solid steel with corrosion resistant finish.
<b>Braided Ladders:</b>	Shall be 100% polyester yarn color coordinated with the slats. Spacing shall not be more than 18.5 mm. (approximately 17 slats per foot of drop).
<b>Installation Brackets:</b>	Standard hidden brackets, 1.5" x 1.75" x .042" Zinc Plated Steel. Blinds over 48" wide shall have intermediate supports.
<b>Tassel:</b>	Shall comply with all safety requirements.
<b>Sizes:</b>	Outside mounted window coverings will be made to exact ordered measurements. Inside mounted horizontal blinds will have 1/2" deducted at the factory from width. See Product Limits.

**Product Limits**

<b>Controls (Motorized)</b>	<b>Min. Width</b>	<b>Max. Width</b>	<b>Min. Drop</b>	<b>Max. Drop</b>
Lift/Tilt Left or Right	20"	102"	6"	114" *

Maximum Sq. Footage \*114 Sq. Ft. Under Warranty

\* Exceptions Available Upon Request

	<b>WARNING</b>		<b>ADVERTENCIA</b>
	Cords on window covering products present a potential strangulation hazard.		Las cuerdas y cadenas y persianas presentan un peligro de estrangulación.
	For child safety, consider cordless alternatives or products with inaccessible cords.		Para la seguridad de los niños, considere alternativas sin cuerdas o productos con cuerdas y cadenas inaccesibles.
<small>SAFLAB-3 04/2013</small>	<small>ANSI/WCMA 5.1.4</small>	<small>SAFLAB-3 04/2013</small>	<small>ANSI/WCMA 5.1.4</small>



## Motorized Aluminum Mini Exploded View

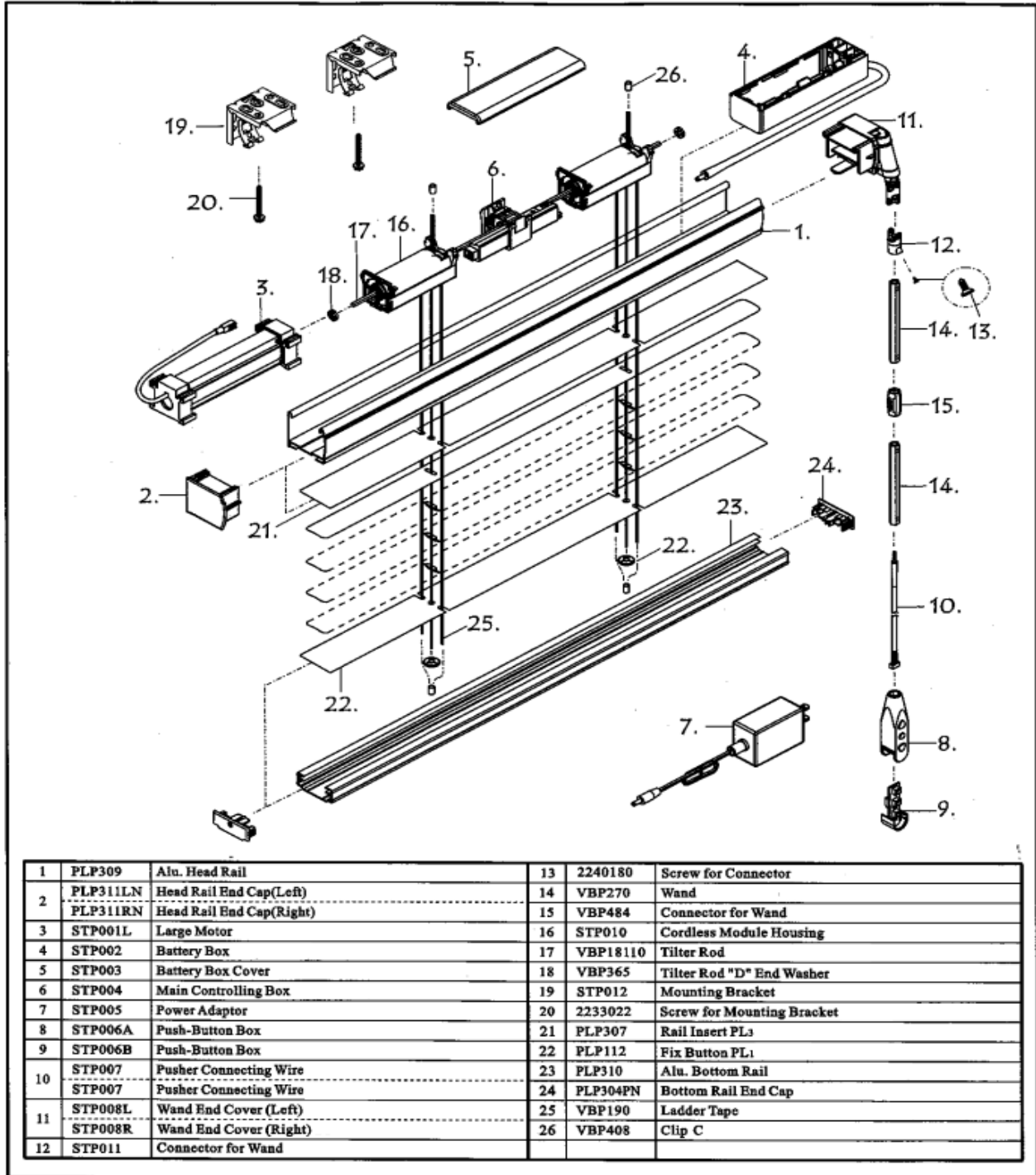



## Commercial Contract Color Options (Check One)

- M1001 Shimmering White
- M1004 Igloo
- M1007 Polar Bear
- M1013 China Stone
- M1022 Coconut
- M1025 Antique Lace