



General:	Assembled by A&I Manufacturing, Inc. Environmentally safe.
Frame:	1 1/2" x 1" 100% aluminum. Baked-on paint.
Head Rail:	1" x 1/2" x 0.024" Steel, integrated style. Treated to resist corrosion. Baked-on paint.
Bottom Rail:	C shaped .024" Steel. Treated to resist corrosion. Baked-on paint.
Extrusion Corner Joint:	2 3/16" x 2 3/16" Nylon 6.
Corner Cover:	1 11/16" x 1 11/16" Nylon 6.
Slats:	Aluminum Heat Treated and Tempered, 1" wide x .006 thick.
Tilter:	Shall be of worm gear construction, enclosed in housing of engineering polymer. May be positioned at right or left.
Tilt Rod:	Shall be solid steel with corrosion resistant finish.
Tilt Wands:	Shall be extruded, clear solid acrylic wand.
Perfect Fit Handle:	Made of Polycarbonate, used to lower and raise blind.
Braided Ladders:	Shall be 100% polyester yarn color coordinated with the slats. Spacing shall not be more than 18.5 mm (approximately 17 slats per foot of drop).
Installation Brackets:	1 3/16" x 1 1/8" x 3/4" or 1 3/16" x 1 1/4" x 1/4" L-shaped spring metal. Treated to resist corrosion. Baked-on paint. Brackets slip between glass pane and muntin, blind clips onto bracket.
Installation:	Blinds will be mounted to window sash or door frame.
Sizes:	Size is determined by width & height of glazing in window sash or door frame. See product limits.

Product Limits

Controls (Manual)	Min. Width	Max. Width	Min. Drop	Max. Drop
Tilt Only Left or Right	14"	57"	12"	67" *

Maximum Sq. Footage *26 Sq. Ft. Under Warranty

* Exceptions Available Upon Request

	WARNING		ADVERTENCIA
	Cords on window covering products present a potential strangulation hazard.		Las cuerdas y cadenas y persianas presentan un peligro de estrangulación.
	For child safety, consider cordless alternatives or products with inaccessible cords.		Para la seguridad de los niños, considere alternativas sin cuerdas o productos con cuerdas y cadenas inaccesibles.
<small>SAFLAB-3 04/2013</small>	<small>ANSI/WCMA 5.1.4</small>	<small>SAFLAB-3 04/2013</small>	<small>ANSI/WCMA 5.1.4</small>



FRONT VIEW

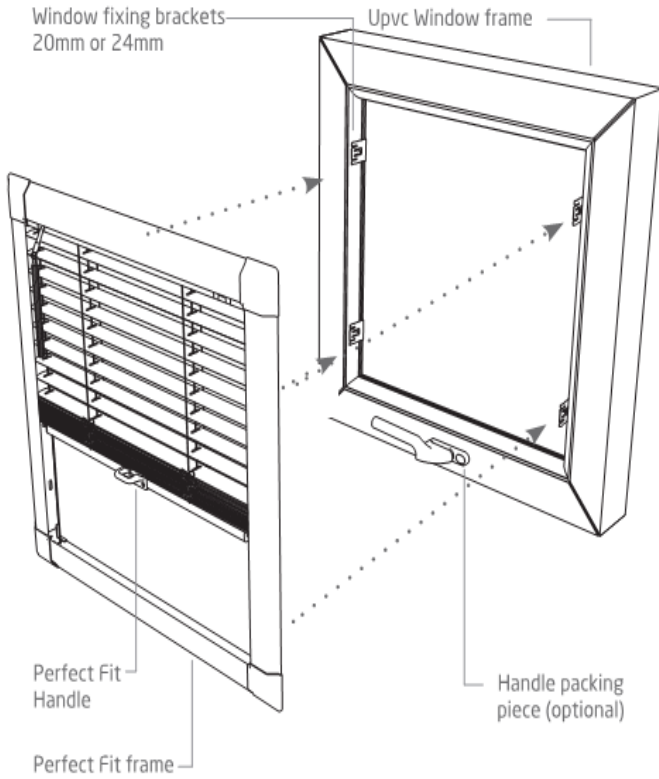

REVERSE VIEW HEADRAIL

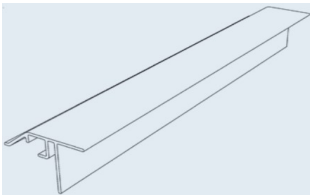
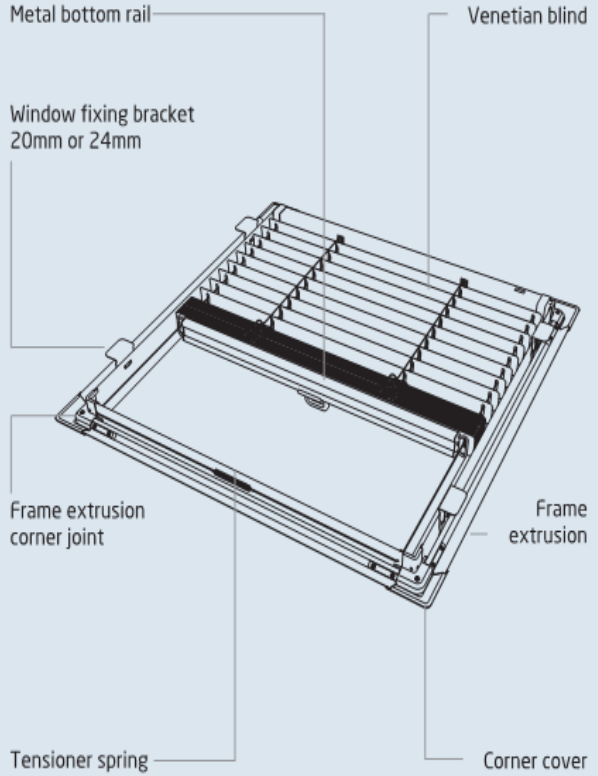

Frame Extrusion

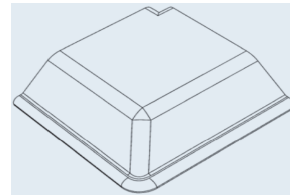

Corner Cover

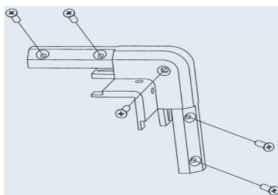

Extrusion Corner Joint

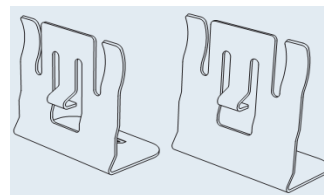

Window Fixing Bracket



Commercial Contract Color Options (Check One)

- M1001 Shimmering White
- M1004 Igloo
- M1007 Polar Bear
- M1013 China Stone
- M1022 Coconut
- M1025 Antique Lace